



## Folding arm awnings

Trentino Mini  
Trentino  
Toscana Mini  
Toscana  
Toscana Grande



## Full-cassette awnings

Just  
*enjoy* life!

**Lewens**  
MARKISEN

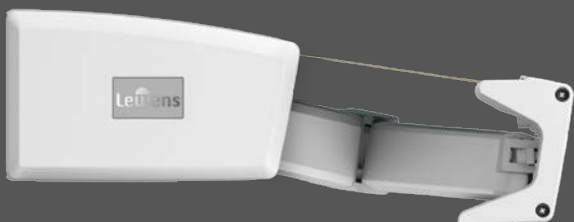



## Successful sunshade products since 1998

Based in Ludwigslust, Lewens has been manufacturing high-quality awning and glass roof systems for over 20 years. These range from simple to complex to meet every requirement.

The development of models and equipment options is influenced just as much by current trends as by the wishes and suggestions of specialist dealers and customers. This is how product series like the full cassette awnings featured here come into being: the Trentino and Toscana model families, both with an unmistakable appearance and unique shape, are characterised by their innovative design and high level of functionality.

Production takes place in a fully integrated operation - from the design and making up of the fabric to assembly – on a site covering over 22000 m<sup>2</sup>. High-grade materials, well thought-out design and precision in cutting and parts production, together with computer-aided automation in the manufacturing process, form the basis for products distinguished by their extreme reliability.

Consultancy and sales are entrusted to competent retailers, along with installation and on-site servicing. This creates proximity to the customer and ensures optimal service, so that our customers can just enjoy life!



*Quality "made in Germany":*

*all awnings and glass roofs from Lewens are  
manufactured and assembled in Germany.*



Just  
**enjoy** life!

Trentino Mini



Trentino



Toscana Mini



Toscana



Toscana Grande



## Contents

### Models

<b>Trentino Mini</b>	4
The small flat cassette	
<b>Trentino</b>	6
“Angular” or “Rounded” type	
<b>Toscana Mini</b>	8
The small round cassette	
<b>Toscana</b>	10
A modern classic	
<b>Toscana Grande</b>	12
Large-scale shade	

### Equipment

<b>Quality and technology</b>	14
Focus on function and workmanship	
<b>Comfort options</b>	16
Vario Valance, electrics and wireless	
<b>Fabrics and colours</b>	18
Fabric collection and choice of frame colours	
<b>Technical data</b>	20
at a glance	

### To match

<b>Micro 700</b>	22
Side screen awning	



## Comfort on a small scale

- Width max. 450 cm,  
drop max. 250 cm
- Snug wall fitting
- Cassette H 11.8 x D 20.9 cm
- Electric motor
- Options:  
Radio motor/  
radio remote control,  
automatic weather sensor,  
LED lighting,  
support legs



## Trentino Mini – the small flat cassette

Full-cassette awning for balconies and small outdoor seating areas

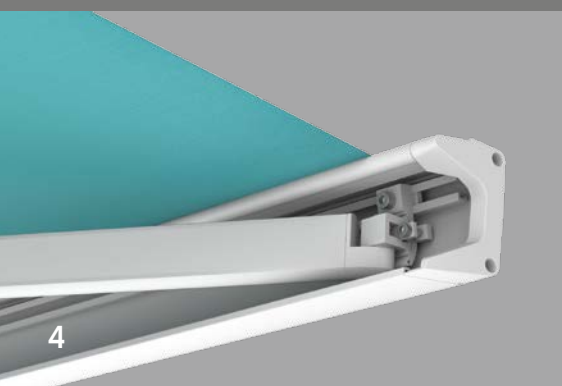

**Function enhanced by design**  
– the connection of folding arms  
to front profile

**Elegance and stability**  
– the arm brackets

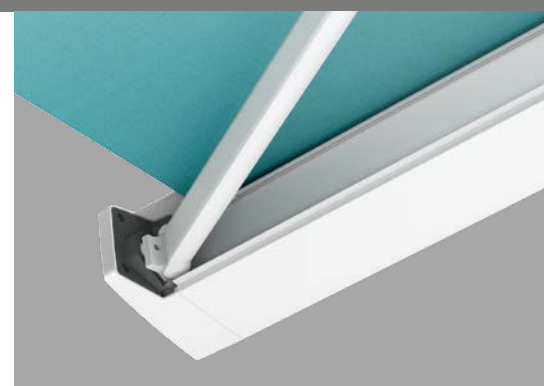



The **Trentino Mini** creates a snug seating area and adds a splash of colour to small patios.

The angular design of the Trentino Mini creates a particularly harmonious combination with modern geometrical architecture and current trends. Like the large models in the Trentino family, the Trentino Mini offers a high level of comfort and superior quality standard. It can be equipped with a variety of optional extras.

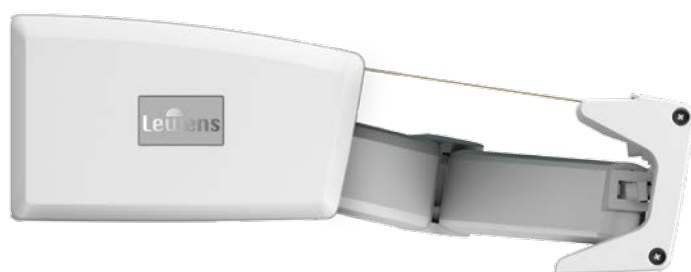

## Full cassette

Enclosed all around and measuring just 11.8 cm in height, the cassette reliably protects the awning from the effects of the weather.



**Trentino Angular**  
with front profile in a linear,  
angular shape.

**Vario Valance** (option)  
The Vario Valance offers variable shade from  
the sun and glare protection, especially  
when the sun is low in the sky, without  
any loss of headroom under the awning.



Trentino – the flat cassette to suit every style  
Full-cassette awning for large patios and outdoor seating areas



## Full cassette

Enclosed all around and measuring just 16.1 cm  
in height, the cassette reliably protects the  
awning fabric from the effects of the weather.  
It fits snugly against the wall, creating a harmo-  
nious transition between awning and façade.



- Width of single unit max. 700 cm, joined system max. 1.950 cm, drop max. 400 cm
- Snug wall fitting
- Electric motor
- Options:  
Radio motor/radio remote control, automatic weather sensor, LED lighting, radiant heater, support legs, Vario Valance (Angular type)

## Angular type

*The clean shape of the angular front profile creates a particularly harmonious combination with modern façade design.*

*Cassette: H 161 x D 261 mm*



## Rounded type

*The rounded front profile with its soft contours sets the right tone for traditional construction forms.*

*Cassette: H 161 x D 252 mm*



The Angular and Rounded model variants of the Trentino full-cassette awning offer versatile design options for large patios and balconies. The Angular type with its linear, angular front profile forms the perfect complement to modern geometrical architecture, while the design of the Trentino Rounded model was developed with classical construction styles in mind.



**Trentino Rounded**  
*With its rounded front profile this awning type blends harmoniously into the façade of traditional classic architecture.*



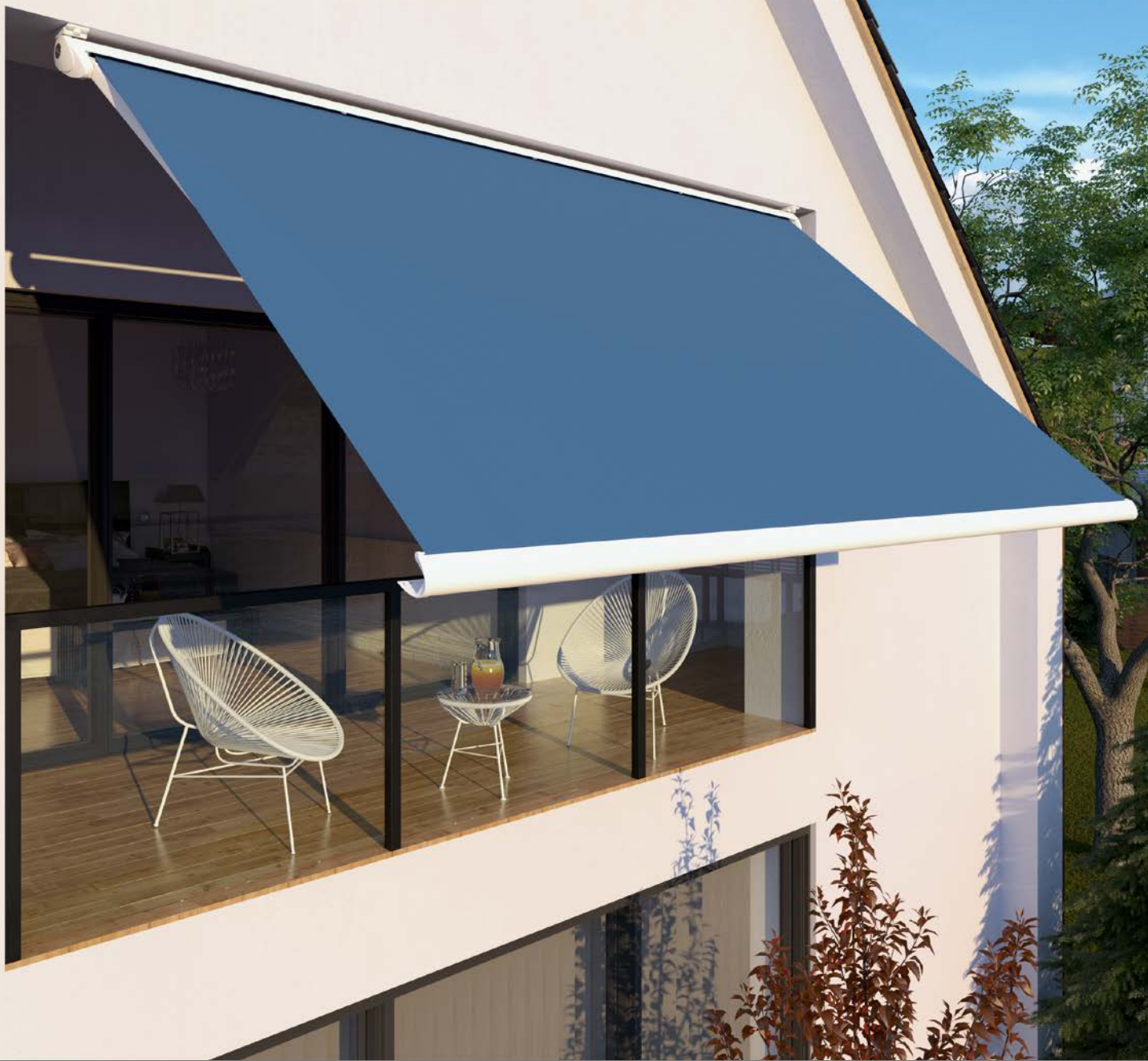

## Toscana Mini – the small round cassette

Space-saving elegance for balcony and loggia



### **Attachment**

*The awning is delivered optionally with brackets facing to the rear (for wall mounting) or upwards (for ceiling mounting). The brackets are located on the outside of the awning in the area of the arm brackets.*

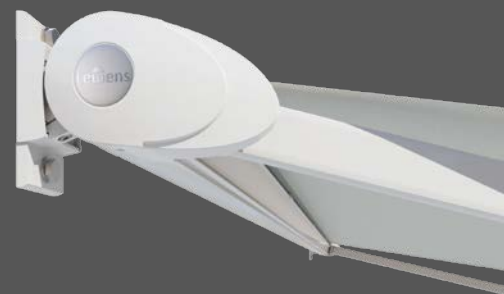



## Compact yet classy

- Width max. 450 cm, drop max. 250 cm
- Electric motor
- Options:  
Radio motor/  
radio remote control,  
automatic weather sensor,  
LED lighting,  
support legs



## Shade and privacy

*Due to the special design of the Toscana Mini, a larger pitch angle can be set during assembly:*

**Possible pitch angles::**

Mounting	Wall	Ceiling
Motor drive	5 - 60 °	5 - 60 °
Crank drive	5 - 27 °	5 - 60 °

*Developed especially for small balconies and areas of shallow depth, the Toscana Mini awning boasts sophisticated technical details and comfort options.*

The smallest full-cassette awning in the Toscana series turns even the smallest balcony into a favourite bolt-hole to relax in. The design of the Toscana Mini permits a steep pitch angle on installation, meaning that it offers privacy and shade even when the sun is low in the sky.

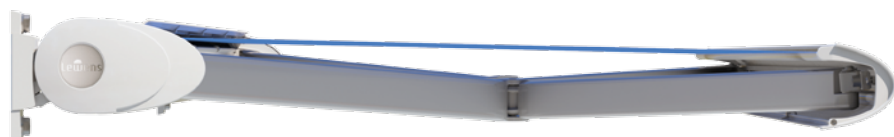

## Full cassette

*The compact cassette, just 10.5 cm high, protects the awning fabric reliably against the effects of the weather when closed.*

*Mounted on the wall or below the ceiling, the Toscana awning creates a light, floating impression.*

*The wide range of awning fabrics from the Lewens collection and choice of frame colours create endless combination and design possibilities.*



## Toscana – playful airiness

A classic for balconies and medium-sized patios



### **Attachment**

*The awning is supplied optionally with brackets facing to the rear (for wall mounting) or upwards (for ceiling mounting). The brackets are located on the outside of the awning in the area of the arm brackets.*



## Equipment and extras

- Width max. 550 cm,  
drop max. 300 cm
- Electric motor
- Options:  
radio motor/radio remote control,  
automatic weather sensor,  
LED lighting,  
support legs

## Shade and privacy

*Due to the special design of the Toscana, a larger pitch angle can be set during assembly.*

*The awning thus offers privacy and shade even when the sun is low in the sky*

### Possible pitch angles:

Mounting	Wall/Ceiling
Motor drive	5 - 80 °
Crank drive	5 - 45 °



As an award-winning classic design from the house of Lewens, the Toscana embodies timeless elegance and adds a stylish touch to any balcony or patio. A particular highlight is that the Toscana can be fitted with an especially large pitch angle, thereby creating additional shade and privacy.

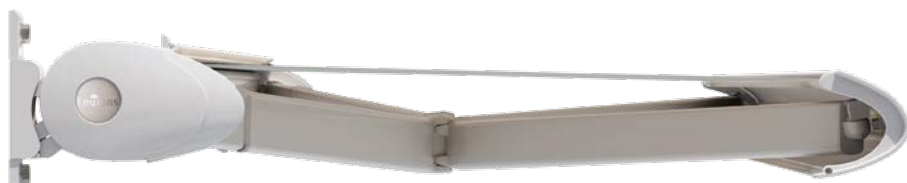

## Full cassette

*The 13 cm high cassette protects the awning reliably against the effects of the weather when retracted.*



## Toscana Grande – large-scale shade

The ultimate in comfort for large patios



### Full cassette

*When the awning is retracted, the front profile closes the cassette completely, protecting both fabric and mechanism reliably from the effects of the weather.*



## Equipment options to increase the comfort

- Width, 1 unit, max. 700 cm, joined system max. 1950 cm, drop max. 400 cm
- Electric motor
- Options:  
Radio motor/radio remote control,  
automatic weather sensor,  
LED lighting  
radiant heater,  
support legs,  
Vario Valance



### **Lightness on a grand scale**

*Up to a width of 650 cm, the Toscana Grande is attached to wall or ceiling using just two brackets (illustration on the left).*

*The bracket attachment is variable thanks to specially developed casing holders, which permit a lateral tolerance on installation*

### **Vario Valance (option)**

*The Vario Valance offers variable shade from the sun and glare protection, especially when the sun is low in the sky, without any loss of headroom under the awning.*

The biggest full-cassette awning in the Toscana series with a self-supporting, oval casing presents a convincing combination of compactness and elegance and is especially suitable for large patios. When mounted on wall, ceiling or rafters, the Toscana Grande appears to float, radiating a notable lightness, even in large formats or as a joined system.



### **Privacy**

*The optional Vario Valance also guards against unwanted attention from outside. If Soltis woven fabric is selected, the view outwards is retained.*





## Quality and technology made in Germany

Thanks to their clean design, quality and a variety of equipment options, full-cassette awnings from Lewens make a convincing impression. Centimetre-accurate manufacturing, even in intermediate sizes, ensures a perfect fit in virtually any desired location.



**Full-cassette awnings are folding arm awnings with a self-supporting casing.**  
They are therefore especially compact and space-saving.  
Enclosed all round, they protect the retracted awning and mechanism reliably from the effects of the weather.

Durable and robust:

**Arm bracket** of high-strength aluminium alloy, upper arm fork of forged aluminium.

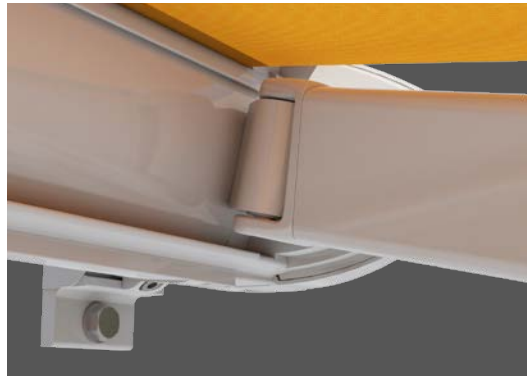

The **front profile bracket** connects the arms securely to the front profile and permits easy adjustment of the angle.

**Central folding arm joints**

A plastic sheath prevents soiling and corrosion of the double cable in the central folding arm joints and extends its service life.

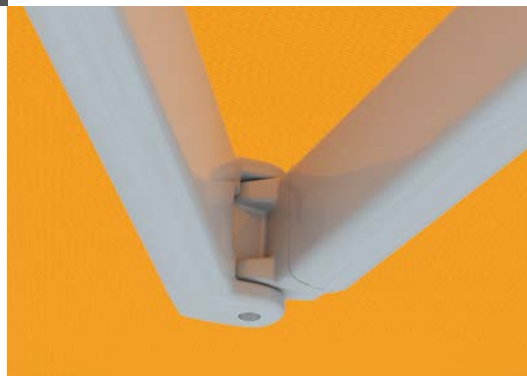

All double cables are greased for improved running with less friction.

The axle pins of the hinges consist of stainless steel.

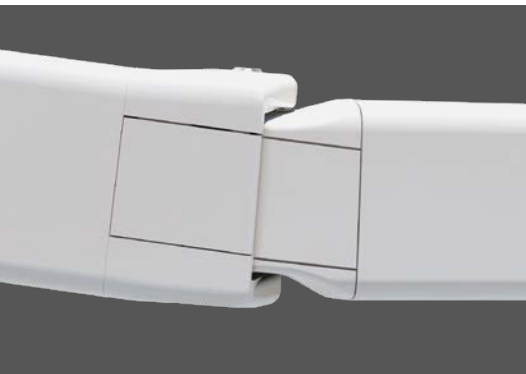

The extremely high **spring tension** of the folding arms guarantees a superbly taut sit of the fabric and largely prevents the awning fabric from resting on the arm hinges.

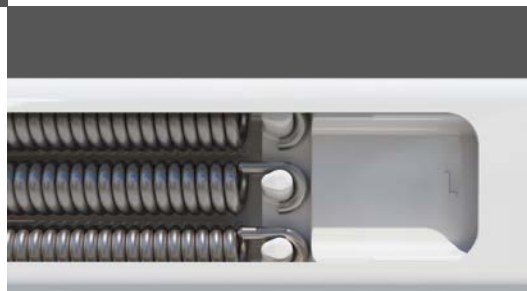

## Guaranteed quality



TÜV-tested quality and CE standard:

Look out for the seal and the mark guaranteeing the technical safety of our products.



**Branded goods from Germany:**

Lewens awnings are manufactured and assembled in Germany – quality “made in Germany”!

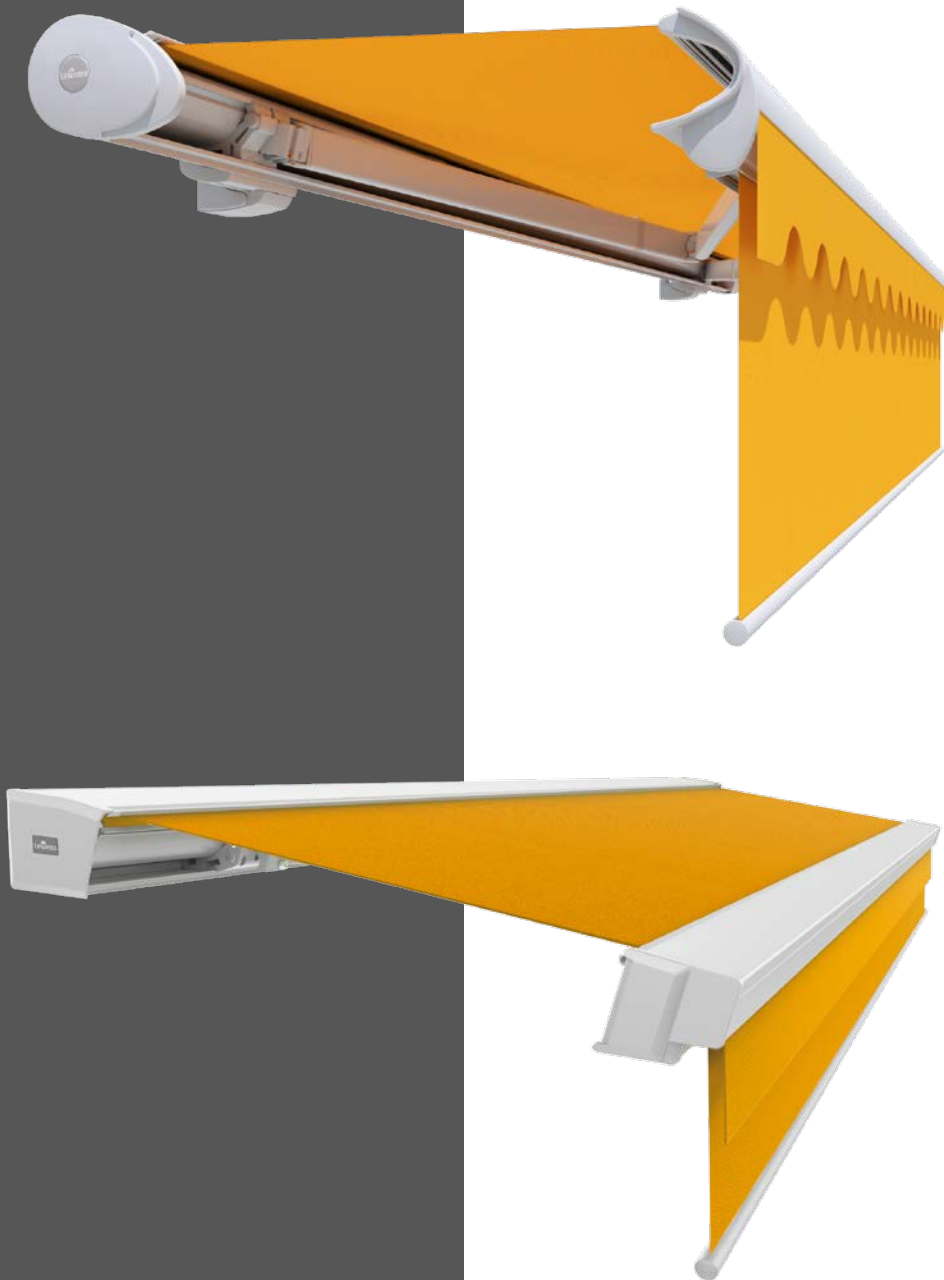

### Models

- Toscana Grande
- Trentino

### Standard equipment

- Supplied as standard with crank operation and acrylic awning fabric
- Hanging heights: 150 and 200 cm
- For systems up to 600 x 300 cm or 500 x 350 cm
- Always with additional short valance

### Extras

*surcharge]*

- Awning in Soltis 92 (hanging height then approx. 160 cm)
- Vario Valance with radio motor (only on awning with radio motor; hanging height then 150 cm in acrylic and 160 cm in Soltis 92)

*Not in connection with radiant heater.*

## Vario Valance Option

The Vario Valance offers variable shade and privacy while retaining the headroom below the awning. When the awning is retracted, the Vario Valance can also be used as a window blind, creating shade and a cool climate inside.

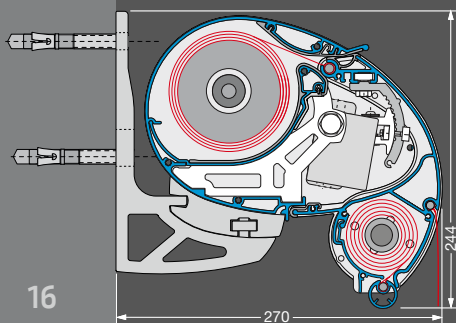

**Toscana Grande**  
with Vario Valance option

**Trentino**  
with Vario Valance option

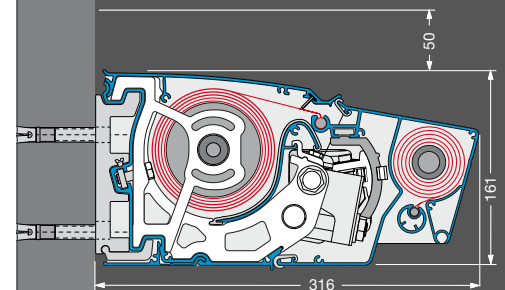





**Radio controllers in io technology from Somfy** create the prerequisites for integrating all patio functions into the home automation system (TaHoma, Connexoon), with convenient operation by tablet or smartphone.



**Automatic weather sensor**  
Sun and wind monitors and wind sensors to io standard ensure automatic, weather-dependent control of awnings – even when there's no one at home.



**Infrared radiant heaters**  
to io standard provide cosy warmth under awnings and glass roofs, even on chilly days



## Options

### Electrical

Want more than the wall switch for operation and other comfort features too? Then you have the choice of radio control systems, lighting, radiant heater and automatic weather sensor components meeting the current Somfy io standard, which can be integrated into the home automation system (TaHoma, Connexoon). All patio functions can thus be conveniently operated via tablet or smartphone.

**LED lighting**  
Equipped with a radio receiver for io technology, suitable mood lighting for any situation can be created by remote control or via the home automation system.

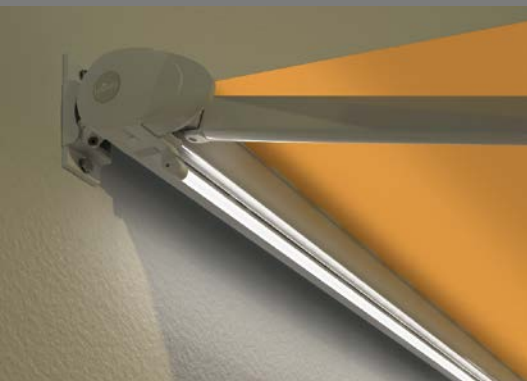

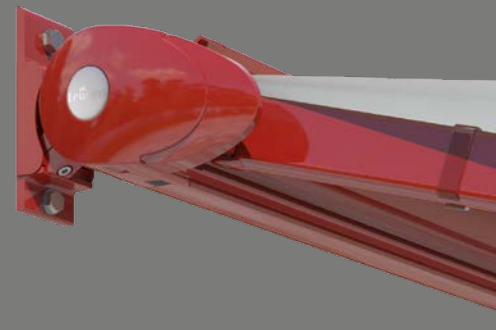
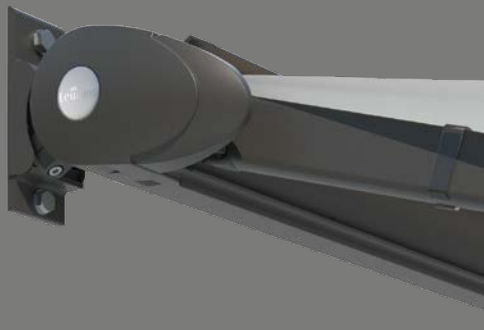

Standard RAL colours **at no extra charge:**

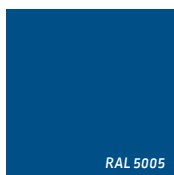
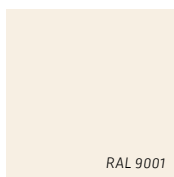
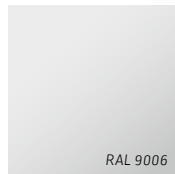

Textured finishes **at no extra charge:**

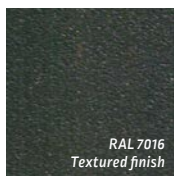

# Frame colours to order

The frames of Lewens awnings and glass roofs are given a high-grade powder coating, rendering them particularly UV- and weather-resistant. An optional preanodising treatment increases the durability of the coating for products used in coastal regions. Hundreds of RAL colours and textured finishes are available to choose from, including a wide range of contemporary colours offered as standard at no extra charge.

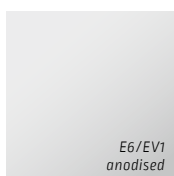

As well as powder-coated finishes, the frames of nearly all models are also offered in **natural silver**.  
Finish: frame in **E6/EV1 silver anodised**,  
small components such as hinge parts, brackets etc. powder-coated in silver RAL 9006.

With well over 300 designs to choose from, the Lewens collection offers you high-quality, spun-dyed acrylic and polyester fabrics that retain their colour brilliance for a long time. Semi-transparent, glass fibre woven screen fabrics and Soltis 92 complete the range, which features modern and classic designs, solid colours, fine textures and 3D effects across the entire colour spectrum.

Lewens awning fabrics have been created especially for use outdoors and are treated to make them water- and dirt-repellent. We make the awnings up using the latest sewing techniques for distortion-free seams and also using ultrasonic bonding. We have designed our manufacturing facility so that the awning fabrics can be laid out entirely flat (not folded) for making up.

**Some of our quality features:**

- Secure lockstitch used for making up, optionally also with ultrasonically bonded seam (surcharge).
- Awning and valance are produced from one piece (identical repeat pattern)
- Seams on top and bottom and valance seam neatened (clean completion)
- Repeat-symmetrical completion left and right
- Use of Tenara® quality sewing yarn (also for valances)

# The Collection

Fabrics ranging from modern to classic

Valance styles



Style 1



Style 2



Style 3



Style 4

# Trentino

Equipment and technical features



Manufactured and assembled in Germany  
TÜV-tested safety  
Quality and technology CE-compliant



Trentino Mini



Trentino



Trentino

Type		Angular	Rounded
Full cassette, flat cassette (H x D)	118 x 209 mm	161 x 261 mm	161 x 252 mm
<b>Widths (max.)</b>			
1 unit (Einzelfeld)	450 cm	700 cm	700 cm
2 units/3 units (joined system with slit cover)	-	1.200 / 1.950 cm	1.200 / 1.950 cm
<b>Drops</b>			
Arm lengths 150 / 200 / 250 cm	■	■	■
Arm lengths 300 / 350 / 400 cm	-	■	■
Special arm lengths	□	□	□
<b>Drive</b>			
Electric motor (for wall switch)	■	■	■
Radio motor (io or RTS)	□	□	□
Crank drive	□	□	□
<b>Frame colours</b>			
17 RAL colours and 6 textured finishes (Lewens standard colours)	■	■	■
Natural silver (E6/EV 1 anodized, small components RAL 9006)	■	■	■
Special RAL, special colours and effect finishes	□	□	□
<b>Awning fabrics from the LEWENS collection</b>			
Branded acrylic (spun-dyed, ultra fade resistant)	■	■	■
Branded polyester (spun-dyed, ultra fade resistant)	□	□	□
Tenara quality sewing yarn	■	■	■
Ultrasonic seam welding	□	□	□
<b>Valance</b>			
without valance	■	■	■
with valance	-	□	□
<b>Options</b>			
1   Radio motor + radio remote control (io or RTS)	□	□	□
2   Automatic weather sensor (sun, wind, rain)	□	□	□
3   Lighting – LED lighting strip	□	-	-
– LED spot bar	-	□	□
4   Radiant heater (not with 6; with 3 only wall attachment)	(* □)	□	□
5   Support legs (not with 2)	□	□	□
6   Vario Valance (not with 4)	-	□	-
<b>Attachment</b>			
Wall	■	■	■
Ceiling	□	□	□
Rafters	□	□	□

Possible dimensions and restrictions along with the complete range of electronic accessories can be found in the technical data in the current Lewens price list.

■ Standard □ Option – not available  
\* only wall attachment

Trentino Mini

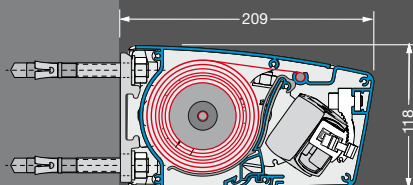

Trentino Angular type

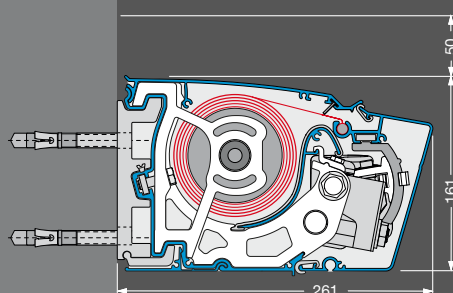

Trentino Rounded type

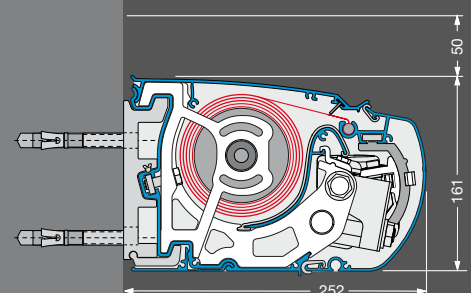

# Toscana

Equipment and technical features



Toscana Mini



Toscana



Toscana Grande

Full cassette (H x D)	105 x 185,5 mm	130 x 223 mm	157 x 239 mm
<b>Widths (max.)</b>			
1 unit (Einzelfeld)	450 cm	550 cm	700 cm
2 units/3 units (joined system with slit cover)	–	–	1.200 / 1.950 cm
<b>Drops</b>			
Arm lengths 150 / 200 / 250 cm	■	■	■
Arm lengths 300 cm	–	■	■
Arm lengths 350 / 400 cm	–	–	■
Special arm lengths	□	□	□
<b>Drive</b>			
Electric motor (for wall switch)	■	■	■
Radio motor (io or RTS)	□	□	□
Crank drive	□	□	□
<b>Frame colours</b>			
17 RAL colours and 6 textured finishes (Lewens standard colours)	■	■	■
Natural silver (E6/EV 1 anodized, small components RAL 9006)	■	■	■
Special RAL, special colours and effect finishes	□	□	□
<b>Awning fabrics from the LEWENS collection</b>			
Branded acrylic (spun-dyed, ultra fade resistant)	■	■	■
Branded polyester (spun-dyed, ultra fade resistant)	□	□	□
Tenara quality sewing yarn	■	■	■
Ultrasonic seam welding	□	□	□
<b>Valance</b>			
without valance	■	■	■
with valance	□	□	□
<b>Optionen</b>			
1   Radio motor + radio remote control (io or RTS)	□	□	□
2   Automatic weather sensor (sun, wind, rain)	□	□	□
3   Lighting – LED lighting strip	□	□	–
– LED spot bar	–	–	□
4   Radiant heater (not with 6; with 3 only wall attachment)	(* □)	(* □)	□
5   Support legs (not with 2)	□	□	□
6   Vario Valance (not with 4)	–	–	□
<b>Attachment</b>			
Wall	■	■	■
Ceiling	■	■	□
Rafters	□	□	□

Possible dimensions and restrictions along with the complete range of electronic accessories can be found in the technical data in the current Lewens price list.

■ Standard □ Option – not available  
\* only wall attachment

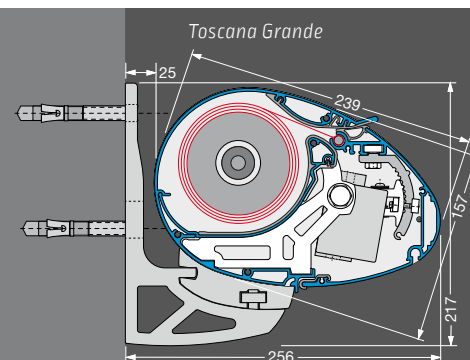
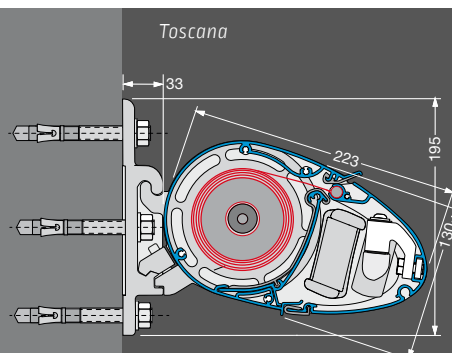
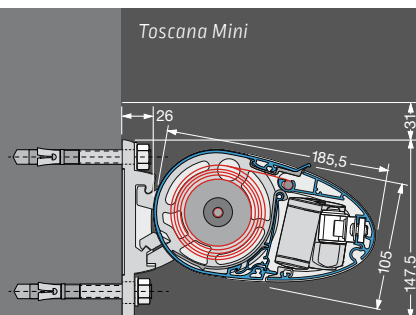

# TO MATCH:



## Micro 700 – side screen awning

The perfect complement to the folding arm awning

*The Micro 700 is simply extended using the **handle** (position and number optional) and hooked onto the wall mounting or post.*

*The **bottom castor** enables the awning to be guided easily. The awning shaft is fitted with an anti-kickback brake for safe, convenient operation.*



Wall cassette (W x D)	108,8 x 100,6 mm		
<b>Unit height (max.)</b>			
1 unit (single panel)	250 cm		
<b>Extension (max., depending on fabric and height)</b>	Height up to 134 cm	Up to 190 cm	Up to 250 cm
Acrylic/Polyester	400 cm	300 cm	300 cm
Soltis 92	400 cm	400 cm	300 cm
<b>Drive</b>			
Manual operation, 1 handle	■		
Manual operation, further handles	□		
<b>Frame colours</b>			
17 RAL colours and 6 textured finishes (Lewens standard colours)	■		
Natural silver (E6/EV 1 anodized, small components RAL 9006)	■		
Special RAL, special colours and effect finishes	□		
<b>Awning fabrics from the LEWENS collection</b>			
Branded acrylic (spun-dyed, ultra fade resistant)	■		
Soltis 92	■		
Branded polyester (spun-dyed, ultra fade resistant)	□		
Tenara quality sewing yarn	■		
Ultrasonic seam welding	□		

Possible dimensions and restrictions along with complete range of accessories can be found in the technical data in the current Lewens price list.

■ Standard □ Option

The Micro 700 side screen awning provides shelter from the sun, wind and unwanted attention, creating a snug refuge on the patio, balcony or loggia. The Micro 700 complements the conventional sunshade in terms of function and design. The fabrics of all Lewens products can be perfectly coordinated with one another.

#### Installation

Wall mounting (standard)

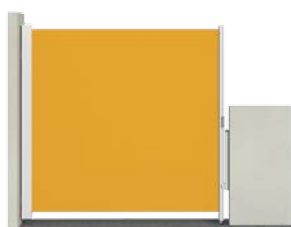

Screwed to base

(instead of standard)

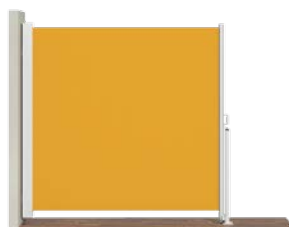

Screwed to base

with base console





[www.lewens-markisen.de](http://www.lewens-markisen.de)



Your stockist will be happy to advise you: